

Varenummer: 0106035  
 Beskrivelse: Seeger låsering JV 19

## Mål

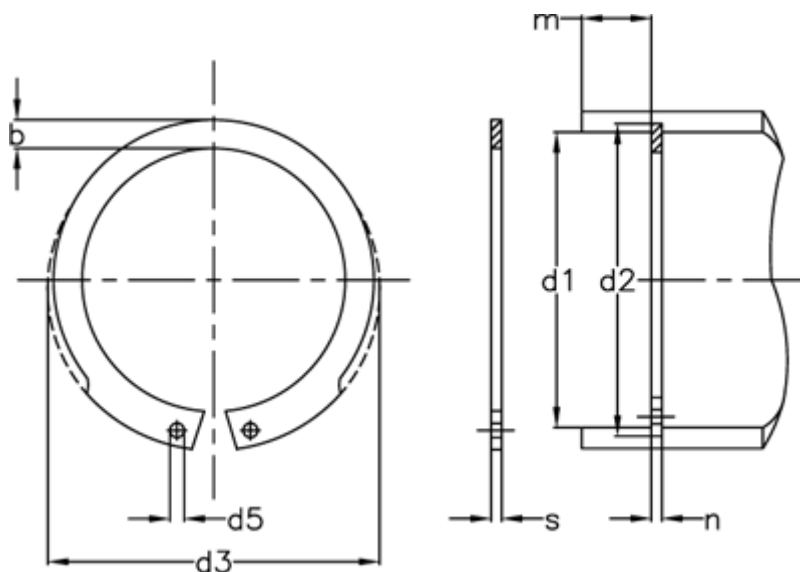

AN mm <sup>2</sup>	= 15	FRg kN	= 2.8	Tang	= ZGJ-1
b	= 2.2	FR kN	= 6.6	tol	= -0.06
Betegnelse	= JV 19	g	= 1.0	tol	= +0,42-0,13
d1	= 19	K kN-mm	= 19.2	tol	= +0,15
d2	= 20.0	m min	= 1.10	tol	= 0.1
d3	= 20.5	Nominel træk	= 1.5	vægt kg/1000	= 0.66
d5 min	= 1.3	s	= 1.00		
FN kN	= 2.50	t	= 0.50		